



The Best Parts For Water Pumps



SPAREPARTS & ACCESORIS CATALOG

- ✓ Lengkap & Beragam Jenis Suku Cadang
- ✓ Kokoh & Tahan Lama
- ✓ Pengaplikasian Yang Universal
- ✓ Memiliki Ukuran Yang Bervariasi



Scan Disini!!!

www.sanei-pump.co.id

DEFFUSER

DEFFUSER

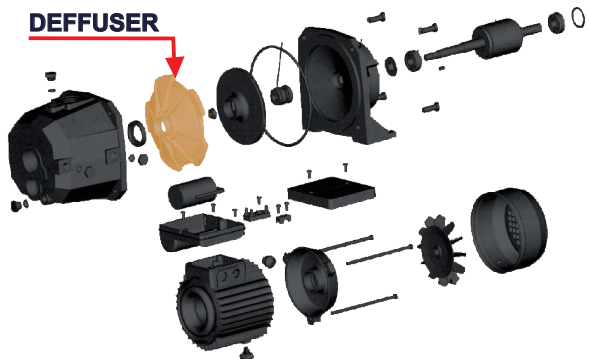

Keunggulan Produk

- Terbuat dari bahan plastik PPO kualitas tinggi
- Stabilitas Dimensi yang Tinggi
- Tahan Terhadap Korosi (Anti Karat)
- Bobot Ringan namun memiliki ketahanan yang kuat



DEFFUSER GS 250



DEFFUSER JP 255 (HS)



DEFFUSER PKR
50 - 300



DEFFUSER JET
100 SE BIASA (SHM)



DEFFUSER SEMI
JET 100



DEFFUSER JET 100 (HS)



DEFFUSER SYO
ABU-ABU



DEFFUSER JP 505

END COVER

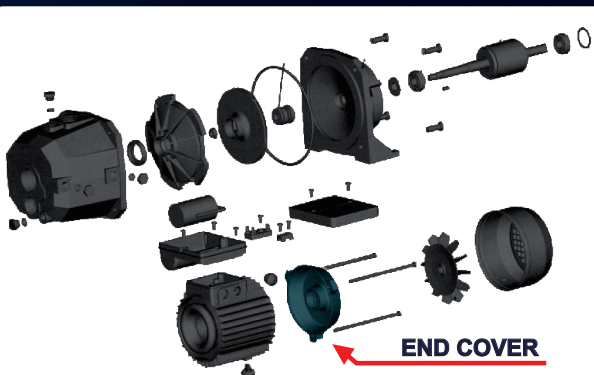

SEMI JET 100



SEMI JET JP 255



JP 505

Keunggulan Produk

- Terbuat dari bahan babet besi kualitas tinggi
- Pelepasan Panas (Thermal Conductivity) yang Sangat Baik
- Kokoh dan Anti-Penyok (High Durability)
- Reduksi Getaran dan Kebisingan

IMPELLER COVER

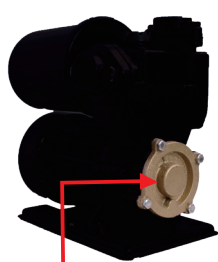

IMPELLER COVER



IMPELLER CAP
MS 125 B



IMPELLER CAP GP
129/125



IMPELLER CAP GP 200



IMPELLER CAP PN 125

FAN COVER



FAN COVER



FAN COVER BOOSTER
SEB 2 - 4



FAN COVER BOOSTER
SEB 4 - 4 - SEBP 4 - 5



FAN COVER
PKR 050 - 300 - 3

Keunggulan Produk

- Terbuat dari bahan plastik dengan kualitas yang tinggi

Keunggulan Produk

- Mengurangi kebisingan dan getaran dengan baik
- Meningkatkan sistem pendinginan
- Optimalisasi aliran udara (Airflow Guide)
- Proteksi keamanan maksimal

IMPELLER KUNINGAN / STAINLESS & PPO

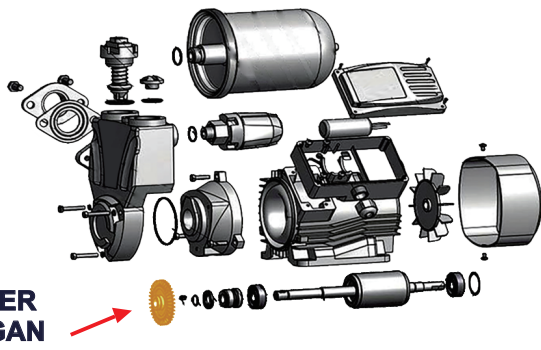

IMPELLER KUNINGAN

Keunggulan Produk

Ketahanan abrasi yang luar biasa

Anti Karat & Korosi

Presisi Optimal

Kekuatan Mekanik Tinggi

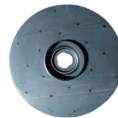

IMPELLER STAINLESS SEB 2 - 4



IMPELLER SJ 250 STAINLESS



IMPELLER SATELITE STAINLESS 4SE3

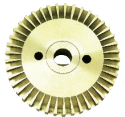

IMPELLER KUNINGAN GP 200



IMPELLER KUNINGAN GP 125



IMPELLER KUNINGAN PS 105 / SHM 130



IMPELLER KUNINGAN SYO 136 / PWH 136



IMPELLER KUNINGAN SHM 226 / 230



IMPELLER KUNINGAN DB 125 / ST 100



IMPELLER KUNINGAN 503



IMPELLER KUNINGAN ST 100 / PN 125



IMPELLER KUNINGAN IM 8 / SYO 100



IMPELLER KUNINGAN IM 10 / SYO 130



IMPELLER KUNINGAN MS 125 B KUNINGAN



IMPELLER KUNINGAN KS 125 KECIL



IMPELLER KUNINGAN PN-200



IMPELLER KUNINGAN 402



IMPELLER KUNINGAN 403



IMPELLER KUNINGAN IM 12 / SYO 250



IMPELLER KUNINGAN IM 120 / GS 125



IMPELLER KUNINGAN PS-221

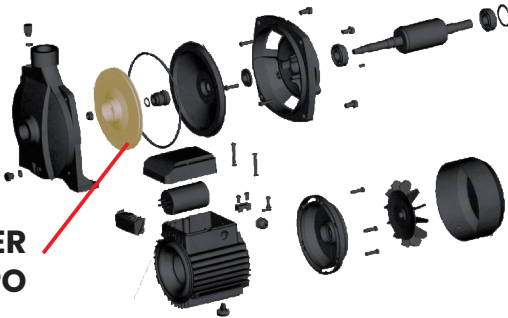

IMPELLER PPO

Keunggulan Produk

Stabilitas Dimensi (Tidak Berubah Bentuk)

Bobot Sangat Ringan

Tahan Terhadap Abrasi Halus

Terbuat dari bahan plastik PPO & POM



IMPELLER JET - 100 DRAT PPO



IMEPELLER JET 100 SPI (PPO HS)



IMPELLER JP 255



IMPELLER GS 250 / SHM 250



IMPELLER JP 370



IMPELLER PC 260 / SHM 260



IMPELLER SHM JET-100 MODEL LAMA



IMPELLER SHM JET-100 MODEL BARU



IMPELLER SJ 265



IMPELLER JET-195 DRAT PPO



IMPELLER JP-255 SYD



IMPELLER AL 255



IMPELLER AL 370



IMPELLER SHM-108



IMPELLER 750AB



IMPELLER 500AB



IMPELLER PKR 050 - 300



IMPELLER SATELITE 4 SEP 2



IMPELLER SATELITE 4 SEP 3

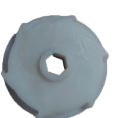

IMPELLER 3 SEP



IMPELLER SATELITE 2.5 SEP



IMPELLER SATELITE 2 SEP



OPEN IMPELLER 401



IMPELLER SEBT

MIDDLE SECTION

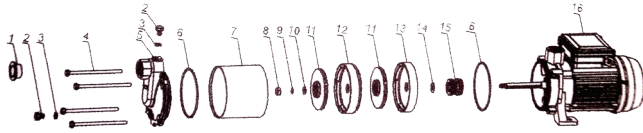

No : 12 & 13 : Middle Section

Keunggulan Produk

Material SS 304 Solid

Anti Karat & Kuat jangka panjang

Higenis dan Food Grade

Memiliki standar sesuai higenis



MIDDLE SECTION SEB 2 - 4

BRACKET



Keunggulan Produk

Terbuat dari babet kualitas yang tinggi dan padat

Anti karat & Anti korosi

Hantaran Panas Optimal

Tahan Getaran



PUMP BODY

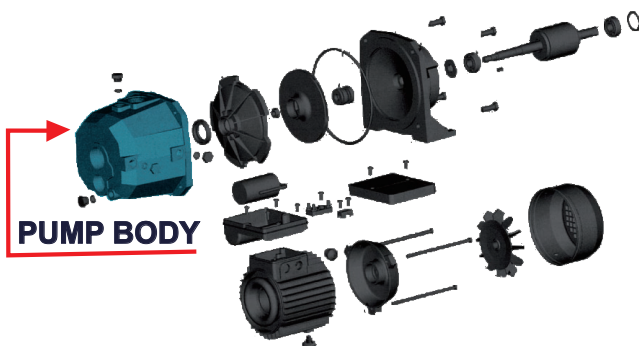

Keunggulan Produk

Terbuat dari babet kualitas yang tinggi dan padat

Telah dilapisi anti karat supaya tahan korosi terhadap air



SULING / JET PIPE

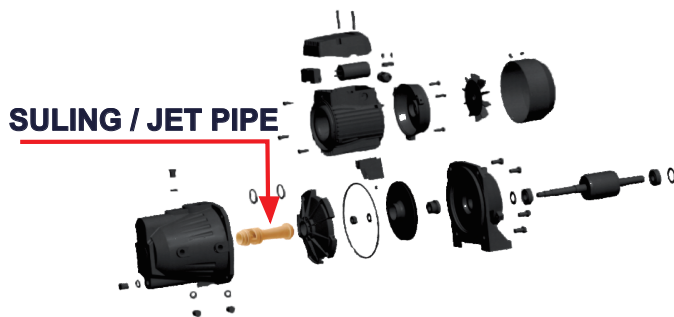

Keunggulan Produk

Terbuat dari bahan plastik PP & PPO kualitas tinggi



MECHANICAL SEAL

MECHANICAL SEAL



Keunggulan Produk

Terbuat dari stainless 304 yang anti karat

Bahan keramik terbuat dari karet keramik kualitas tinggi



SEAL JP 255 TYMT



SEAL ST 100



SEAL MS 14 / PDR 255



SEAL DB 255,
370 (KEONG)



SEAL SHM 250 /
SP 151-14

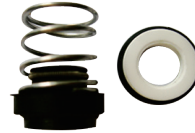

SEAL X 8 / SYO 100



SEAL MS 18 /
505 KEONG



SEAL MS 13 / DB 175



SEAL MS 12 / DB 125



SEAL JP AB 12 /
PS 130 / GS 125



SEAL GP 200



SEAL JP 505 TYMT



SEAL N 100 / GP 125



SEAL JP-10 /
SYO-125 / 130



SEAL JP-12 / SYO-250



SEAL MS 17



SEAL SEC-2200



SEAL SHM 260

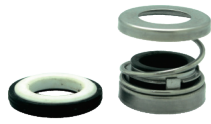

SEAL SATELITE 3"



SEAL SATELITE 4"



SEAL SE-250AB
(208-12)



SEAL SE-500AB



SEAL SE-750AB



SEAL SEC-1800AB



SEAL CATRIDGE 12



SEAL CATRIDGE 16



SEAL CATRIDGE 22



RING SATELITE 2" 2.5"



RING SATELITE 3" 4"



SEAL PKR 050-300



SEAL SEB 2-4 & 4-4



SEAL ENGINE
POWER 2" & 3"

CAPACITOR



CAPACITOR



CAPASITOR DUCATI COLOK

TYPE		VOLTASE
8 uF		450V
10 uF		450V
12.5 uF		450V
14 uF		450V
16 uF		450V
20 uF		450V
25 uF		450V
31.5 uF		450V
40 uF		450V



CAPASITOR MESIN CUCI

TYPE	VOLTASE
CBB60 10uF+4uF	450V
CBB60 10uF+5uF	450V
CBB60 10uF+6uF	450V
CBB60 12uF+4uF	450V
CBB60 12uF+5uF	450V
CBB60 12uF+6uF	450V
CBB60 14uF+4uF	450V
CBB60 14uF+5uF	450V
CBB60 14uF+6uF	450V

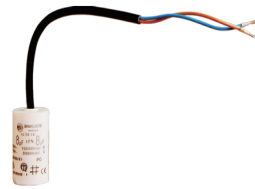

CAPASITOR DUCATI KABEL

TYPE		VOLTASE
8 uF	25 uF	450V
10 uF	31.5 uF	450V
12.5 uF	35 uF	450V
14 uF	40 uF	450V
16 uF	45 uF	450V
20 uF	50 uF	450V



CAPASITOR ALUMINIUM

TYPE	VOLTASE
12 uF	230V
14 uF	230V
16 uF	230V
20 uF	230V
25 uF	230V
30 uF (Besar)	230V
50 uF	230V
60 uF	230V
65 uF	230V



CAPASITOR KOTAK

TYPE		VOLTASE	
1 uF	6 uF	14 uF	450V
1.2 uF	7 uF	16 uF	450V
1.5 uF	8 uF	16 uF	450V
2 uF	10 uF	20 uF	450V
3 uF	10 uF	20 uF	450V
3.5 uF	12 uF	24 uF	450V
4 uF	12 uF	30 uF	450V
5 uF	14 uF		450V



CAPASITOR STARTING

TYPE	VOLTASE
100 uF	250V
150 uF	250V
200 uF	250V
250 uF	250V
300 uF	250V
400 uF	250V
500 uF	250V
600 uF	250V



CAPASITOR AC

TYPE	VOLTASE
20 uF	450V
25 uF	450V
30 uF	450V
35 uF	450V
40 uF	450V
45 uF	450V
50 uF	450V
60 uF	450V



CAPASITOR BULAT WHITE POOL

TYPE		VOLTASE
8 uF	31.5 uF	450V
10 uF	35 uF	450V
12.5 uF	40 uF	450V
14 uF	45 uF	450V
16 uF	50 uF	450V
20 uF	60 uF	450V
25 uF	75 uF	450V



CAPASITOR BULAT

TYPE		VOLTASE
6 uF	25 uF	450V
8 uF	30 uF	450V
10 uF	31.5 uF	450V
12 uF	35 uF	450V
14 uF	40 uF	450V
16 uF (Body Besar)	45 uF	450V
16 uF (Body Kecil)	50 uF	450V
18 uF	100 uF	450V
20 uF	120 uF	450V

Keunggulan Produk

Terbuat dari bahan dielektrik dan metal plate kualitas tinggi

Selalu penuh didalamnya

Mikro farad sesuai dengan yang tertera di kapasitornya

TANGKI

**TANGKI
2 LITER**

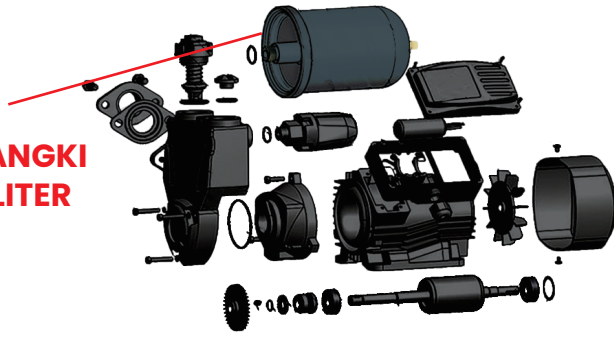

Keunggulan Produk

Terbuat dari stainless 304 yang anti karat

Bahan keramik terbuat dari karet keramik kualitas tinggi



TANGKI 3L POLYMERE



TANGKI 2L POLYMERE



TANGKI 2L BESI



TANGKI SE



TANGKI 19L



TANGKI FIBER SE +
SHOCK WATER MUR



TANGKI 60L - 500L



TVT
(Pengukur Tekanan Berdasarkan Permittaan)



Dengan Pengukur Untuk Referensi



NVT
(Pengukur Tekanan Berdasarkan Permittaan)



WVT
(Pengukur Tekanan Berdasarkan Permittaan)

MODEL	TEKANAN MAX	(mm)		PENYAMBUNG	TEKANAN PRECHARGE	PACKING (CBM)
		DIAMETER	TINGGI			
SET-60L	10 BAR	380	835	1"	1,5	0,13808
SET-80L	10 BAR	450	785	1"	1,5	0,15998
SET-100L	10 BAR	450	870	1"	1,5	0,17820
SET-150L	10 BAR	500	1135	1"	2	0,30233
SET-200L	10 BAR	628	1080	1 1/2"	2	0,46819
SET-300L	10 BAR	628	1360	1 1/2"	2	0,58305
SET-500L	10 BAR	790	1465	1 1/2"	2	0,93440

Butyl : -20°C/99°C

EPDM : -20°C/99°C

Karet Natural : 0°C/77°C

GAS BAG



GAS BAG

Keunggulan Produk

Terbuat dari karet EPDM kualitas tinggi



19 LITER HITAM EPDM

STEEL PLATE

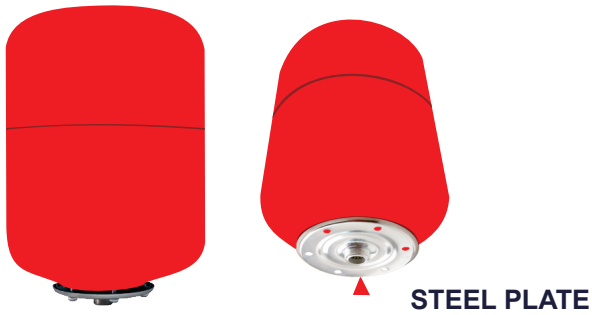

Keunggulan Produk

Terbuat dari material plate yang kuat dan berkualitas



STEEL PLATE

TEE JOINT

TEE JOINT KUNINGAN



Keunggulan Produk

Terbuat dari kuningan kualitas tinggi

Terbuat dari babet kualitas tinggi



KUNINGAN (1")



BESI (1")

BRASS SWITCH CONTROL

BRASS SWITCH CONTROL

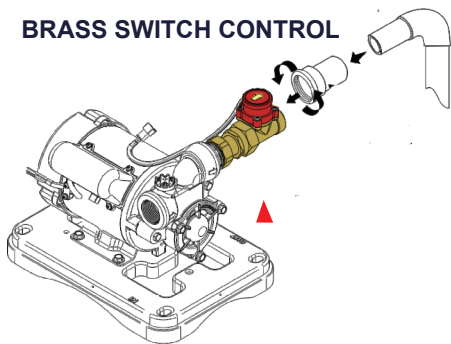

Keunggulan Produk

Terbuat dari kuningan kualitas tinggi

Terdapat chip didalamnya

Dilengkapi dengan kabel tembaga



BRASS SWITCH CONTROL 1/2"



BRASS SWITCH CONTROL 1"



FLOW SWITCH PLASTIK 1"

PLANNES

PLANNES / FLANGE



Keunggulan Produk

Menggunakan bahan plastik original & bermutu



PLANNES / FLANGE PWH-131

FLOATING BALL VALVE

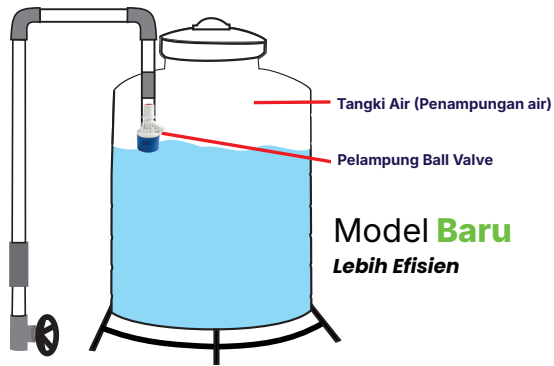

Keunggulan Produk

Dilengkapi dengan seal tape

Tidak perlu menggunakan kabel

Perawatan yang mudah, penggunaan untuk berbagai tempat

Kapasitas air yang besar

Menggunakan bahan plastik yang bermutu dan tahan terhadap panas sinar matahari



FLOATING BALL VALVE STAINLESS 1/2"



FLOATING BALL VALVE SE ECHO T (1/2", 3/4", 1")



FLOATING BALL VALVE SE ECHO H (1/2", 3/4", 1")



PELAMPUNG

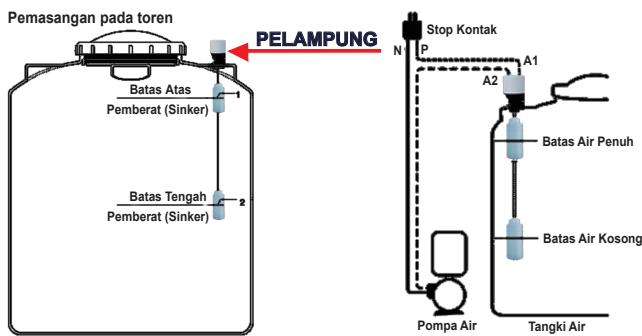

Keunggulan Produk

Menggunakan pengantar listrik perak

Terdapat lubang untuk output hawa panas



SHT-70AB



SE-70AB

FLOAT SWITCH

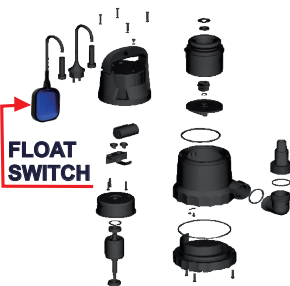

Keunggulan Produk

Menggunakan pengantar listrik perak dan bahan plastik dengan kualitas tinggi



FLOAT SWITCH

MODEL	RATED VOLTAGE	FREQUENCY	RATED CURRENT		PROTECTION GRADE	SIZE OF CABLE	CROSS SECTION	MAX TEMPERATURE
2M & 5M	AC 125/250W	50 Hz	10(4)A/16(4)A	10(8)A/16(8)A	IP 68	3 X 0.75 mm	9mm	55°C

CONTROL BOX

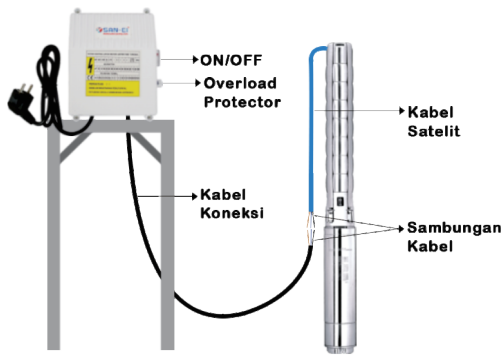

Keunggulan Produk

- Menggunakan kapasitor yang terjamin
- Overload protector yang berkualitas



CONTROL BOX

TYPE 2"	0.25 HP	0.33 HP	0.5 HP	-	-	-	-
TYPE 2.5"	0.25 HP	0.33 HP	0.5 HP	0.75 HP	1 HP	-	-
TYPE 3"	0.25 HP	0.33 HP	0.5 HP	0.75 HP	1 HP	1.5 HP	2 HP
TYPE 4"	0.5 HP	0.75 HP	1 HP	1.5 HP	2 HP	3 HP (3P)	5.5 HP (3P)
TYPE 6"	5.5 HP	7.5 HP	-	-	-	-	-

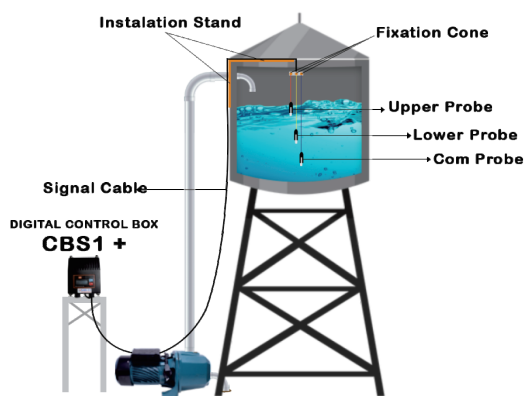

CBS1+

MODEL	POWER	VOLTASE	Hz	IP
CBS1+	0.37 kW	220V	50	54
	0.55 kW			
	0.75 kW			
	1.5 kW			
	2.2 kW			

Keunggulan Produk

- Dapat berfungsi sebagai control box pompa submersible dengan tambahan capacitor sesuai dengan pompa submersible yang dipakai
- Mendeteksi apabila air sumur atau sumber airnya habis, maka pompa akan segera berhenti sehingga pompa lebih aman dan awet
- Bisa mengukur level air telah turun sesuai dengan level yang telah disetel, jika sudah dititik tersebut maka bisa otomatis mengisi toren



CB 18



CB 28

MODEL	POWER	VOLTASE	PH	Hz	A	C	IP
CB 18	0.25 kW	220V / 240V / 230V	1~	50	14	70 uF/450V	54
	0.33 kW						
	0.55 kW						
	0.75 kW						
	1.1 kW						
	1.2 kW						
2.2 kW							

MODEL	POWER	VOLTASE	PH	Hz	A	IP
CB 28	0.55 kW	380V	3~	50	4.4	54
	0.75 kW					
	1.5 kW					
	2.2 kW					
	3 kW					
	4 kW					
	5.5 kW					
7.5 kW						

PREFILTER

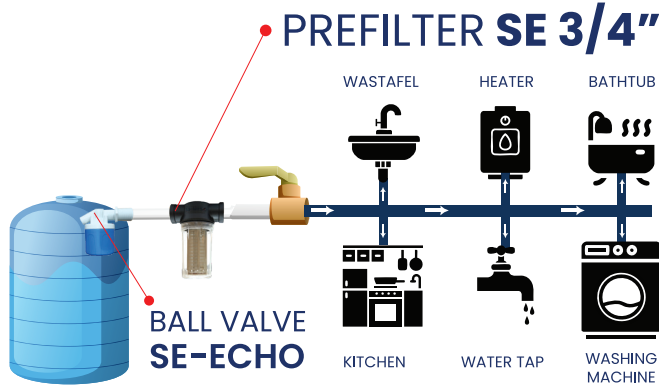

PREFILTER SE 3/4"

Keunggulan Produk

Cara pengaplikasian yang mudah

Menyaring kotoran pada air secara maksimal



PREFILTER T

1/2"
3/4"
1"



PREFILTER JAMUR

1/2"

MATA JET

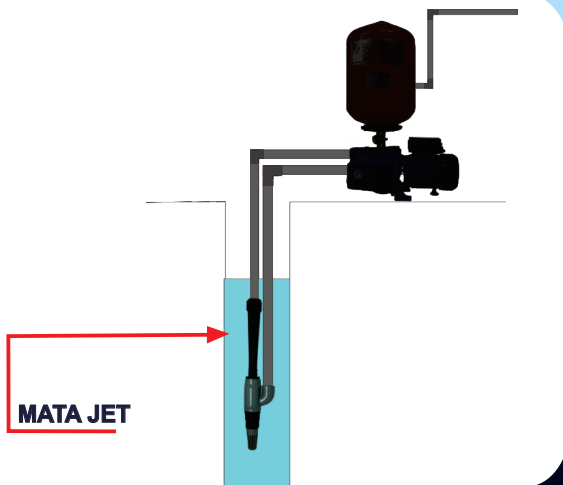

MATA JET

Keunggulan Produk

Spyer terbuat dari bahan kuningan

Membantu pompa untuk menghisap lebih dalam

Suling terbuat dari bahan plastik (POM) berkualitas



MATA JET SYO



MATA JET DB 255

KARBURATOR GASOLINE

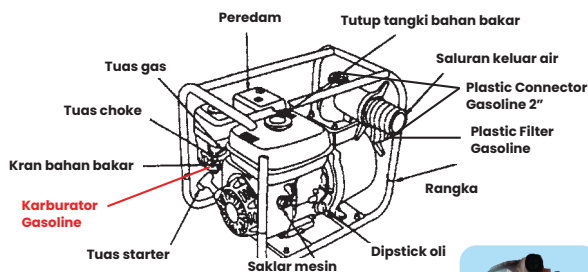

Karburator Gasoline



FOOT VALVE SYO

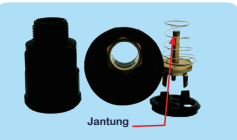

Keunggulan Produk

Presisi Pencampuran Bahan Bakar (Efisiensi Tinggi)

Performa Mesin Stabil & Responsif

Tahan Getaran Tinggi

Keunggulan Produk

Terbuat dari POM kualitas tinggi

Dalamnya dilapisi oleh kuningan sehingga lebih awet

Jantungnya terbuat dari kuningan kualitas tinggi

FOOT KLEP

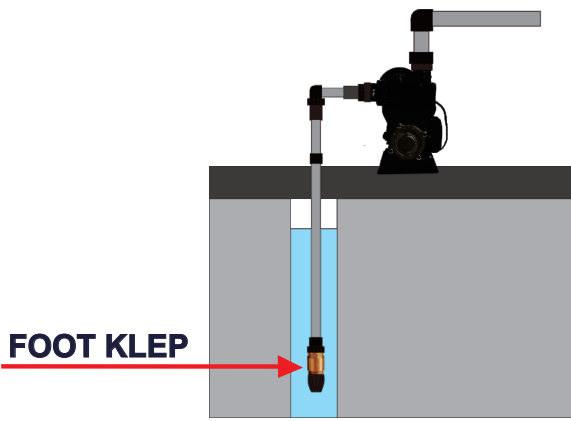

Keunggulan Produk

Terbuat dari kuningan yang kuat & anti bocor
Jantung terbuat dari kuningan berkualitas

1/2" 3/4" 1"



FOOT KLEP SE

1"

Brass Core

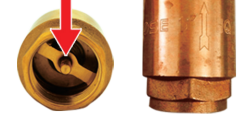

FOOT KLEP 410g HQ

KEPALA FILTER KOLAM RENANG



TIPE

KEPALA FILTER HDPE

HDPE

SFP - 17

SFP - 20

SFP - 24

SFP - 26



TIPE

1.5"

2"

FIBER

SF 16

SF 18

SF 19

SF 22B

SF 23B

SF 20

SF 21

SF 24A

SPUYER

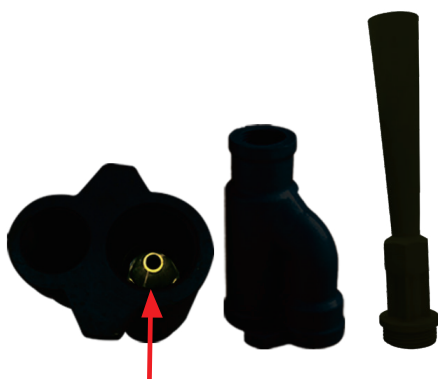

SPUYER (UNTUK MATA JET)



SPUYER KUNINGAN
MATA JET



SPUYER MATA JET
SYO 255



SPUYER MATA JET
PNS 255

GLAND COVER PKR, STRAINER PKR, WATERMUR PKR

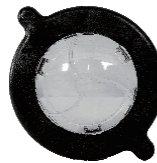

PKR 050 GLAND
COVER OF
TRANSPARAN COVER



PKR 075 - 300
GLAND COVER OF
TRANSPARAN COVER



PKR 050 STRAINER



WATERMUR PKR



PKR 075 - 300
STRAINER

PRESSURE CONTROL

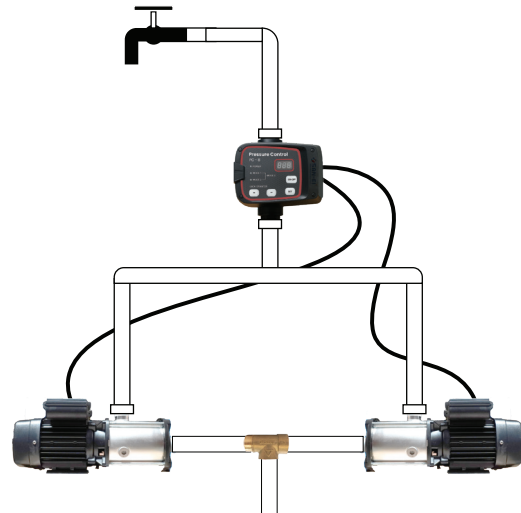
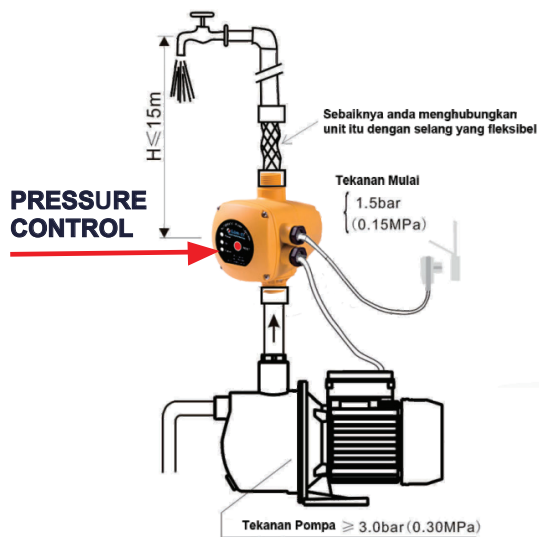

SAN-EI PC 1



TYPE	SAN-EI PC 1
VOLTAGE	220-240V
MAX ELECTRIC CURRENT	10A
FREQUENCY	50/60Hz
PROTECTION CLASS	IP65
STARTING PRESSURE	1.0-2.8 Bar
MAX PRESSURE	10 Bar
FOR PUMP	125-1500W
INLET & OUTLET	1" X 1"

SAN-EI PC 2



TYPE	SAN-EI PC 2
VOLTAGE	220-240V
MAX ELECTRIC CURRENT	10A
FREQUENCY	50/60Hz
PROTECTION CLASS	IP65
STARTING PRESSURE	1.0-3.0 Bar
MAX PRESSURE	10 Bar
FOR PUMP	370-1100W
INLET & OUTLET	1" X 1"

SAN-EI PC 3



TYPE	SAN-EI PC 3
VOLTAGE	220V-240V
MAX ELECTRIC CURRENT	10A
MAX PRESSURE	10 Bar
STARTING PRESSURE	15 Bar or 22 Bar
FOR PUMP	370-1100W
INLET & OUTLET	1" X 1"

PALOMA PP3



Type	PALOMA PP 3
Tegangan	220V-240V
Tekana Maks	10 Bar
Tekanan Awal	1.5 Bar/2.2 Bar
INLET & OUTLET	1" X 1"

SAN-EI PC 4



TYPE	SAN-EI PC 4
VOLTAGE	220V-240V
MAX ELECTRIC CURRENT	10A
MAX PRESSURE	10 Bar
STARTING PRESSURE	0.5 Bar or 2.0 Bar
PROTECTION CLASS	IP54
INLET & OUTLET	1" X 1"

SAN-EI PC 5

*PRESSURE CONTROL PERTAMA SAN-EI
INSTALASI HORIZONTAL ATAU VERTIKAL



Pre-set Pressure	1.5 Bar
Adjustable Pressure	1-6 Bar
Max Power	11 kW
Max Pressure	10 Bar
Max Ambient Pressure	40 °C
Max Liquid Temperature	60 °C
Protection Class	IP65
Connector	G1" Male
INLET & OUTLET	1" X 1"

SAN-EI PC 6



MODEL	PC-6
MAX LIQUID TEMPERATURE	60 °C
MAX PRESSURE	1 MPa (10 Bar)
VOLTAGE RANGE	220V-240V~
FREQUENCY	50/60 Hz
MAX CURRENT	30 A (16 A)
MAX POWER	2.2 kW
INLET & OUTLET	1 1/2" x 1 1/2"

SAN-EI PC 7



DAYA POMPA	0,1-2,2 kW
TEGANGAN MASUK	AC100-240V
SUHU CAIRAN	0-100°C
DAYA ANGKAT POMPA	0-100 m
FREKUENSI	50/60 Hz
INLET & OUTLET	1" x 1"
ARUS MAKSIMUM	30 A
TEKANAN MAKSIMUM	10 Bar
KELAS PERLINDUNGAN	IP65
INLET & OUTLET	1" X 1"

SAN-EI PC 8



DAYA POMPA	0,1-2,2 kW
TEGANGAN MASUK	AC100-240V
SUHU CAIRAN	0-60°C
DAYA ANGKAT POMPA	0-100 m
FREKUENSI	50/60 Hz
INLET & OUTLET	1" x 1"
ARUS MAKSIMUM	16 A
TEKANAN MAKSIMUM	10 Bar
KELAS PERLINDUNGAN	IP54
INLET & OUTLET	1 1/2" x 1 1/2"

BODY PUMP SATELIT & DINAMO / MOTOR

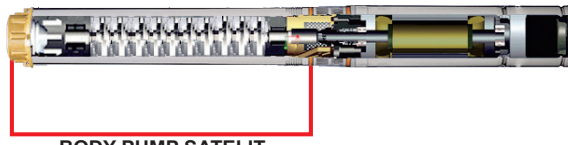

BODY PUMP SATELIT

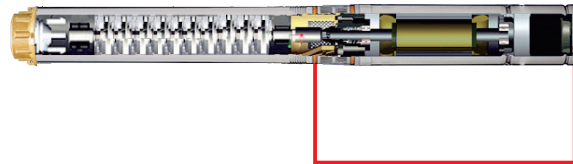

DINAMO / MOTOR POMPA SATELIT

Keunggulan Produk

Terbuat dari stainless 304 yang kokoh dan berkualitas
 Impeller noril terbuat dari plastik POM kualitas tinggi
 Impeller stainless terbuat dari stainless 304

Keunggulan Produk

Terbuat dari kawat tembaga
 Ass rotor terbuat dari SUS 304
 Terinstalasi dengan motor protector



BODY PUMP SATELIT IMPELLER STAINLESS



BODY PUMP SATELIT IMPELLER PLASTIK POM



DINAMO / MOTOR POMPA SATELIT

UKURAN 3 INCH	
HP	TYPE
0.33 HP	2-8
0.5 HP	2-11
0.75 HP	2-16
1 HP	2-21

UKURAN 6 INCH	
HP	TYPE
3 HP	17-4
4 HP	30-3
5.5 HP	30-4
10 HP	30-7
5.5 HP	46-3
7.5	60-3

UKURAN 6 INCH						
HP	TYPE					
0.5 HP	2-7	2-19	3-6			
0.75 HP	2-11	2-13	3-9			
1 HP	2-16	2-18	3-12			
1.5 HP			3-18	5-12		
2 HP			3-25	5-17	8-10	14-5
3 HP			3-33	5-25	8-15	
4 HP				5-33	8-18	14-10
5.5 HP					8-25	

UKURAN	2"	2.5"
HP	TYPE	TYPE
0.25 HP	0.7-26	1.5/12
0.33 HP	0.7/32	1.5/17
0.5 HP	0.7/38	1.5/24
0.75 HP	-	1.5/31
1 HP	-	1.5/40

UKURAN	3"	4"
HP	TYPE	TYPE
0.25 HP	1.8/8	-
0.33 HP	2.5/8	3/5
0.5 HP	2.5/11	3/7
0.75 HP	2.5/16	3/10
1 HP	2.5/21	3/12
1.5 HP	2.5/31	3/17
2 HP	2.5/37	3/22
3 HP	-	3/30

UKURAN 2 INCH
HP
0.25 HP
0.33 HP
0.5 HP

UKURAN 4 INCH
HP
0.5 HP
0.75 HP
1 HP
2 HP
3 HP

UKURAN 2.5 INCH
HP
0.25 HP
0.33 HP
0.5 HP
0.75 HP
1 HP

UKURAN 6 INCH
HP
5.5 HP
7.5 HP

UKURAN 3 INCH
HP
0.25 HP
0.5 HP
0.75 HP
1 HP
1.5 HP
2 HP
3 HP

DEFFUSER & IMPELLER SATELIT

Keunggulan Produk

Terbuat dari stainless 304 berkualitas

Terbuat dari bahan POM berkualitas

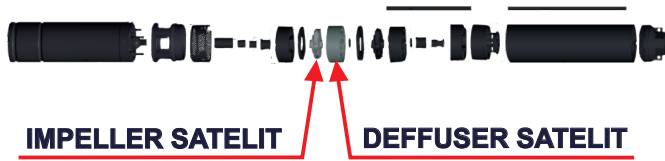

DEFFUSER & IMPELLER SATELIT
STAINLESS 3" & 4"



DEFFUSER & IMPELLER SATELIT
PLASTIK 2" 2.5" 3" & 4"

KABEL SATELIT

CABLE SATELIT

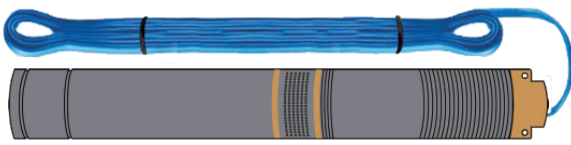

ULIR FOR SATELIT 2"



UKURAN	HP
3 X 0.75 mm 2	0.5
3 X 1.25 mm 2	1
4 X 0.75 mm 2	0.5
4 X 1.25 mm 2	0.75 & 1
4 X 2 mm 2	2
4 X 2.5 mm 2	3



KABEL SATELIT

RUBBER TAPE

Keunggulan Produk

Memiliki bahan rubber yang tebal & tahan air

Menggunakan bahan PVC yang tahan air

KABEL

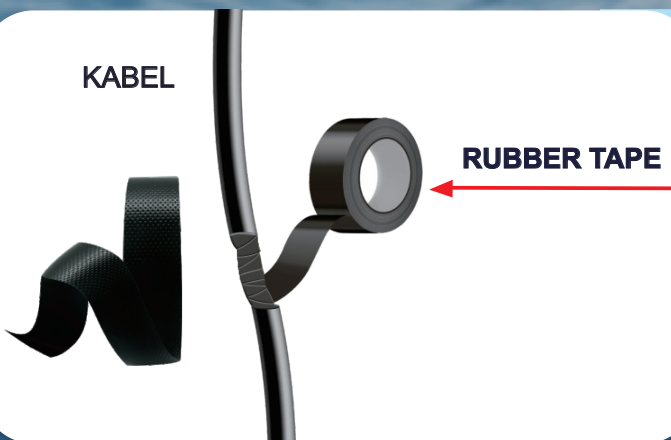

RUBBER TAPE



BLACK RUBBER TAPE
+ PVC TAPE ANTI AIR



BLACK RUBBER TAPE 2M

SWITCH ON OFF & OVERLOAD PROTECTOR



TIPE		
1.5A	6A	15A
2A	7A	18A
3A	8A	20A
3.5A	10A	25A
4A	12A	40A
5A	14A	-

KABEL KONEKSI SET



1



2

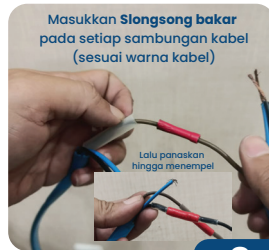

3

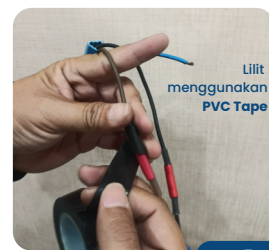

4



5



6



7



Skun kabel konektor

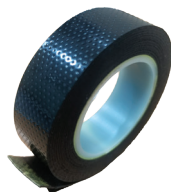

Rubber tape



PVC tape



Selongsong bakar plastik

Keunggulan Produk

Penyambungan lengkap 4 In 1 & daya tahan mekanis yang tinggi

Terdapat panduan pemasangan untuk membantu merakit, universal dan juga fleksibel

Lebih praktis dan terdapat resin kering didalam selongsong bakar, yang akan menempel apabila terkena panas

PRESSURE SWITCH

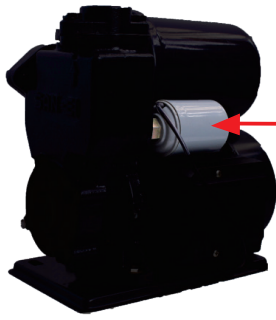

PRESSURE SWITCH



PRESSURE SWITCH



PRESSURE SWITCH
SE PM 5



PRESSURE SWITCH
SE ABU ABU



PRESSURE SWITCH
SAN-EI 1/4" & 3/8"



PRESSURE SWITCH
KIP 1/4" & 3/8"



PRESSURE SWITCH
KIP PM 5



PRESSURE SWITCH NEW
KYUSHU 1/4" & 3/8"



PRESSURE SWITCH
KIP ABU ABU



PRESSURE SWITCH
SE 132 133

Keunggulan Produk

Pengantar listrik menggunakan perak yang kuat

Terbuat dari plastik yang tahan panas

PRESSURE METER

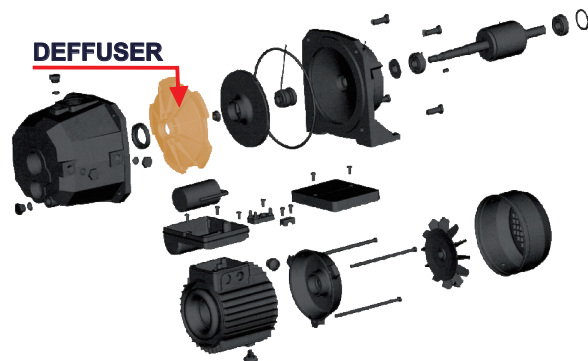

DEFFUSER

Keunggulan Produk

Terbuat dari plat kualitas tinggi

Sambungan terbuat dari kuningan



PRESURE METER GF



PRESSURE METER
1/4" BODY KECIL



PRESSURE METER 3/8"
BODY BESAR DIAMETER 5mm

SEAL TAPE

SEAL TAPE



Keunggulan Produk

Menggunakan bahan PTFE yang berkualitas tinggi dan bahan yang tebal

Mudah digunakan dan pada saat di tarik bahan PTFE akan putus secara rapi dan tertata



SEAL TAPE HACHI

COVER POMPA



BAGIAN BAWAH COVER POMPA

BAGIAN ATAS COVER POMPA

COVER POMPA

Keunggulan Produk

Menggunakan bahan plastik yang berkualitas dan tahan cuaca
Dapat disesuaikan dengan masing masing pompa yang berikut



COVER POMPA



SE-132



SE-156A



SE-256A



SE-228

PIPA FLEKSIBEL POMPA

PIPA FLEKSIBEL POMPA

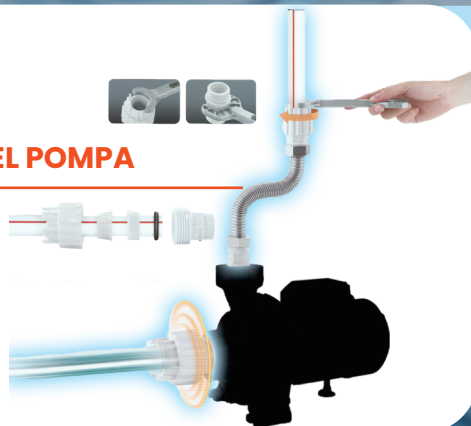

Keunggulan Produk

Memiliki bentuk yang elastis dan fleksibel

Mudah dipasang dan dicopot serta tersedia tools didalamnya

Memudahkan pemasangan setiap pompa yang berbeda beda

Anti bocor dan kokoh



PIPA FLEKSIBEL

SET POOL CLEANER



WALL BRUSH



DEEP LEAF SKIMMER



POOL DRAIN



VACUM HEAD 18"

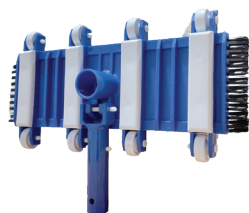

VACUM HEAD 14"



VACUM HOSE 15M



SHADOW WATERLEAF SKIMMER



POOL HOLE 5M



PLASTIC CONNECTION NOZZLE 1.5" & 2"



VACUM HEAD SEGITIGA

SIMULASI PEMASANGAN

Pompa Satelite & Spare parts

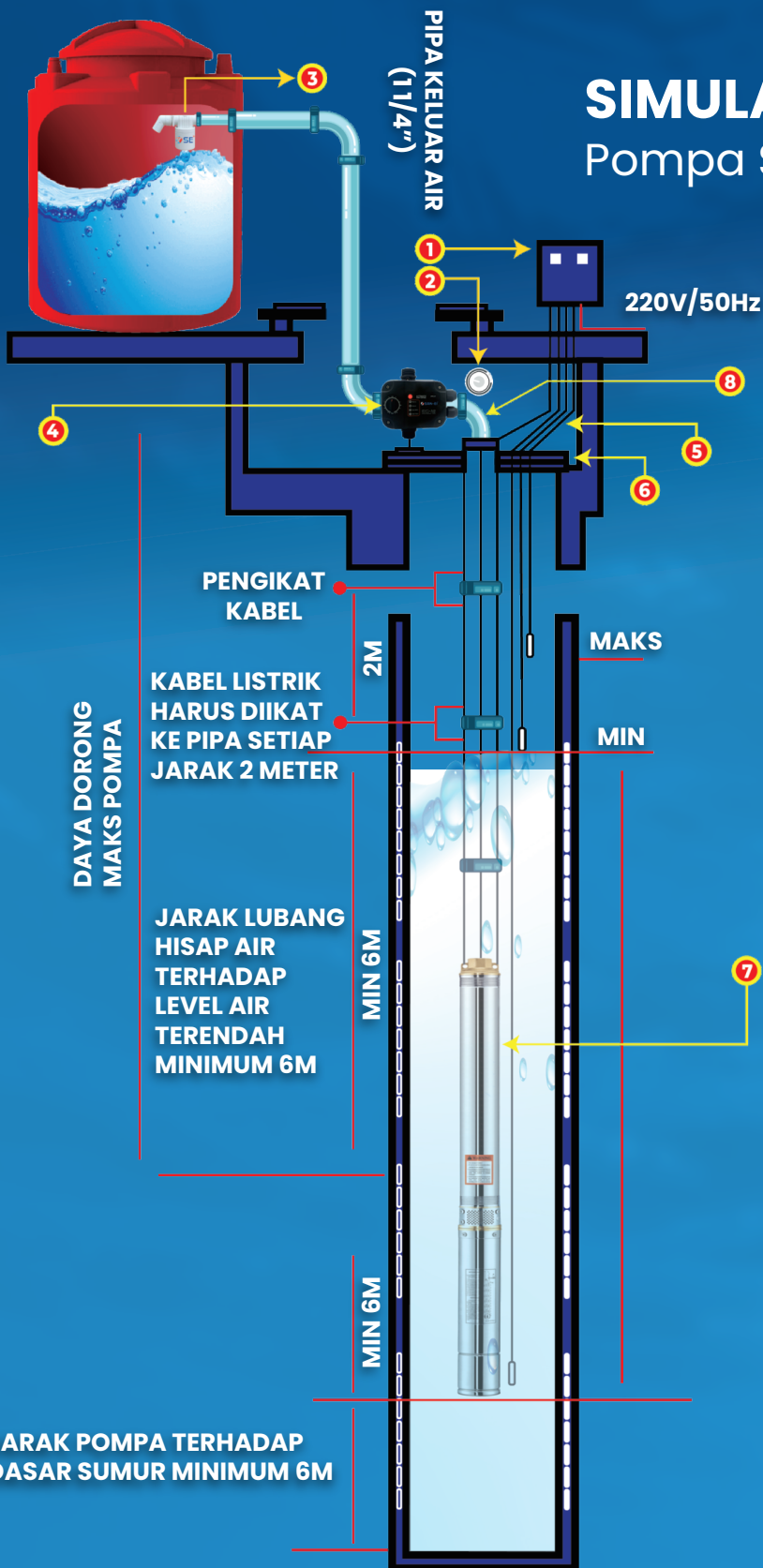

No	Name	
1	Control Box CB 18	
2	Pressure Gauge GF	
3	Ball Valve SE-ECHO T	
4	Pressure Control PC - 1	
5	Kabel Listrik KABEL SATELIT	
6	Klem Penahan Pompa	
7	Pompa Satelite SATELIT NORIL	
8	Pipa Air	

